



**RHYTHM**

## Quickie® Rhythm

BC, SC, MPC

Supplier: This manual must be given to the rider of this wheelchair.

Rider: Before using this wheelchair read this entire manual and save for future reference.

**Owner's Manual**



**SUNRISE LISTENS**

Thank you for choosing a Quickie wheelchair. We want to hear your questions or comments about this manual, the safety and reliability of your chair, and the service you receive from your Sunrise supplier. Please feel free to write or call us at the address and telephone number below:

Sunrise Medical  
Customer Service Department  
7477 East Dry Creek Parkway  
Longmont, Colorado 80503  
(303) 218-4500 or (800) 333-4000

**FOR ANSWERS TO YOUR QUESTIONS**

Your authorized supplier knows your wheelchair best, and can answer most of your questions about chair safety, use and maintenance. For future reference, fill in the following:

Supplier: \_\_\_\_\_

Address: \_\_\_\_\_  
\_\_\_\_\_

Telephone: \_\_\_\_\_

Serial #: \_\_\_\_\_ Date/Purchased: \_\_\_\_\_

**USER WARNING**



**WARNING**  
Attention wheelchair users, do not operate this wheelchair without first reading the owner’s manual. If you do not understand the instructions and warnings of this owner’s manual please contact your dealer or qualified technician before operating this Quickie wheelchair. Failure to do so may result in damage and/or injury.

**DEALER/TECHNICIAN WARNING**



**WARNING**  
Attention dealers and qualified technicians, do not operate or service this wheelchair without first reading this owners manual. If you do not understand the instructions and warnings of this owners manual please contact the Quickie Technical Service Department before operating and/or servicing this Quickie wheelchair. Failure to do so may result in damage and/or injury.



**WARNING**  
In addition, power wheelchairs may contain printed circuit boards. Careful attention should be given to the Printed Circuit Board Handling Techniques insert supplied with the chair.

**Related Documents**

Listed below are additional documents which are referenced in this owners manual.

- RNET Owners Manual
- RNET OBP Owners Manual
- RNET Omni Owners Manual

<b>I. INTRODUCTION</b> .....	2	P. Power Recline .....	13
<b>II. TABLE OF CONTENTS</b> .....	3	Q. Power Legrest Accessory .....	13
<b>III. YOUR CHAIR AND ITS PARTS</b> .....	4	R. Transit Use .....	13
<b>IV. NOTICE - READ BEFORE USE</b> .....	5	<b>VIII. SET UP, ADJUSTMENT &amp; USE</b> .....	14
<b>V. EMI (ELECTROMAGNETIC INTERFERENCE)</b> .....	5	Notes .....	14
A. What is EMI .....	5	Tools You Will Need .....	14
B. What Effect Can EMI Have .....	5	Check Out .....	14
C. Sources of EMI .....	6	A. Battery Removal .....	15
D. Distance From the Source .....	6	B. Folding Backrest .....	15
E. Immunity Level .....	6	C. Swing-Away Footrests .....	16
F. Report All Suspected EMI Incidents .....	6	D. Elevating Legrests (Optional) .....	16
G. EMI From Chair .....	6	E. Center Mount Hanger Adjustment .....	16
<b>VI. GENERAL WARNINGS</b> .....	7	F. Joystick and Enhanced Display .....	17
A. Notice to User and Attendants .....	7	G. Joystick Retractable Mount (Optional) .....	17
B. Weight Limit .....	7	H. Dual-Post Height-Adjustable Armrests (Optional), Fixed Height Standard .....	17
C. Controller Settings .....	7	I. Single Post Height-Adjustable Armrests (Optional) .....	18
D. EMI .....	7	J. Seat Depth .....	18
E. Safety Checklist .....	7	K. Transit Option .....	18
F. Changes & Adjustments .....	8	<b>Seating System Setup</b> .....	19
G. When Seated in a Parked Wheelchair .....	8	A. A.S.A.P. Seating Adjustment .....	19
H. Environmental Conditions .....	8	B. Seat Pan and Back Size Adjustments .....	19
I. Terrain .....	8	C. Pre-Tilt (Packer Module Only) .....	19
J. Street Use .....	8	<b>Seating System Adjustment</b> .....	19
K. Motor Vehicle Safety .....	8	A. Manual Recline Operation .....	19
L. Center of Balance .....	9	B. Power Recline Tilt/Lift Operation .....	19
M. Transfers .....	9	<b>IX. OPERATING GUIDE</b> .....	20
N. Reaching or Leaning .....	9	A. Performance Control Settings .....	20
O. Dressing or Changing Clothes .....	9	B. On-Board, DTT, or RNET PC Programmer .....	20
P. Obstacles .....	9	C. Thermal Roll-Back .....	20
Q. Driving in Reverse .....	9	D. Fuses .....	20
R. Ramps, Slopes & Sidehills .....	9	E. VR2 Joystick Assembly .....	21
S. To Reduce the Risk of Falls, Tip-over or Loss of Control .....	10	F. LED Joystick .....	22
T. Ramps at Home & Work .....	10	G. Color LCD Screen .....	23
U. Wheelchair Lifts .....	10	H. Motor Locks .....	24
V. Curbs & Single Steps .....	10	<b>X. BATTERIES</b> .....	25
W. Stairs .....	10	A. Introduction .....	25
X. Escalators .....	10	B. Battery Charger .....	25
<b>VII. WARNINGS: COMPONENTS &amp; OPTIONS</b> .....	11	C. Acid Burns .....	25
A. Armrests .....	11	D. Connecting Batteries in Battery Compartment .....	25
B. Batteries .....	11	E. Charging Batteries .....	26
C. Cushion & Sling Seats .....	11	F. Disposing of Batteries .....	26
D. Fasteners .....	11	<b>XI. MAINTENANCE</b> .....	26
E. Footrests .....	11	A. Notes .....	26
F. Motor Lock .....	11	B. Cleaning .....	26
G. On/Off Switch .....	11	C. Storage Tips .....	26
H. Pneumatic Tires .....	11	D. Battery Maintenance .....	27
I. Positioning Belts (Optional) .....	12	E. Pneumatic Tires .....	27
J. Push Handles .....	12	F. To Repair or Replace a Tire .....	27
K. Seating Systems .....	12	G. Ordering Parts .....	27
L. Upholstery Fabric .....	12	H. Maintenance Chart .....	27
M. Power Seating .....	12	<b>XII. WIRING DIAGRAMS</b> .....	28
N. Assignable Controls .....	12	<b>XIII. SUNRISE LIMITED WARRANTY</b> .....	30
O. CG Tilt Power Accessory .....	13		

## III. YOUR CHAIR AND ITS PARTS

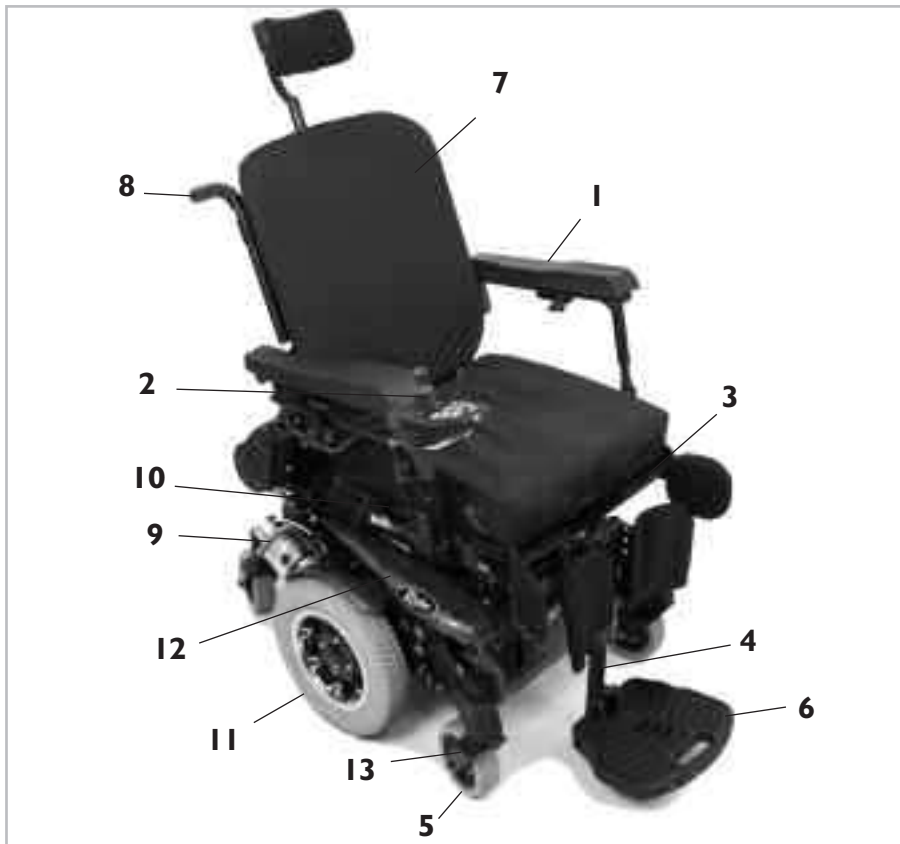

1. Armrest
2. Joystick
3. Seat Pan
4. Front Hanger
5. Caster Tire
6. Foot Plate
7. Backrest
8. Push Handle
9. Free-wheel Release Lever
10. Seat Frame
11. Drive Wheels
12. Base Frame
13. Caster Fork
14. Transit Tie Down (not shown)

## QUICKIE RHYTHM

**Base Chair User Weight Limits\***

300 lbs to 400 lbs

\*Weight capacity may vary due to options chosen, refer to appropriate order form.

**Drive Wheels**

14" x 3"

Tire types: Standard - pneumatic  
Option - solid insert

**Tilt (Option)\***

50° CG Tilt

300 lb capacity

**Joystick**

Standard - Joystick (right-hand or left-hand mount, fixed)

Option - swing-away mount

**Batteries**

(2 deep cycle batteries required to operate chair)

Option - Group 24 gel or 22NF gel

**Battery Charger**

Standard - 8 amp off-board

**Backrest**

Traditional Rehab - Fixed or Folding, non-recline: 16" - 24"

Option - Fixed w/manual recline: 15", 17", 19"

Option - JAY SPO / ART SPO

Option - Power recline

**Seat Frame Dimensions**

Frame width:

Traditional Rehab - 12" - 22"  
(1" increments)

Seat depth:

Traditional Rehab - 12"-22"  
(1" increments)

Seat height:

Traditional Rehab - 17" - 20"  
(1" increments)

Seat : Traditional Rehab - Solid seat

Option-cushion: 2" (50mm)

**Seats, Upholstery and Style**

Standard- A.S.A.P. Seat Frame

(BC, SC only):

Sizes: 16" - 20" wide, 16" - 20" deep

**Caster Fork**

Standard - Fixed

**Footrest**

Standard - Swing-away with composite footplate.

Option - Swing-away tapered (75°) or swing-away straight (65°), elevating legrests, angle-adjustable footplate, extended, toe loops, extension tubes,

solid one-piece, two piece locking

**Casters**

6" solid

**Armrests**

Standard - (Rehab) dual post with standard or full length pad, fixed height, adjustable flip-back arms (Perfect Fit)

Option - (Rehab) dual post height-adjustable, height-adjustable with standard or full length pad, recline height-adjustable (Perfect Fit)

Standard? 14" Flip back, height adjustable 14" arm pad (BC, SC)

Option- Locking, two-point arm

All features may not be available with some chair setups or in conjunction with another chair feature. Please consult your supplier for more information. Your authorized supplier can also provide you with more information on accessories.

## A. CHOOSE THE RIGHT CHAIR & SAFETY OPTIONS

Sunrise provides a choice of many power wheelchair styles, sizes and adjustments to meet the needs of the user. However, final selection of a wheelchair rests solely with you and your health care professional. Choosing the best chair for you depends on such things as:

1. Your size, disability, strength, balance and coordination.
2. Your intended use, and your level of activity.
3. The types of hazards you must overcome in daily use (in areas where you are likely to use your chair).
4. The need for options for your safety and comfort (such as positioning belts or special seat systems).

## B. ADJUST CHAIR TO YOUR ABILITY

You need to work with your doctor, nurse or therapist, and your supplier, to fit this chair and adjust the controller settings for your level of function and ability.

## C. REVIEW THIS MANUAL OFTEN

Before using this chair you, and each person who may assist you, should read this entire Manual and make sure to follow all instructions. Review the warnings often, until they are second nature to you.

## D. WARNINGS

The word “WARNING” refers to a hazard or unsafe practice that may cause severe injury or death to you or to other persons. The “Warnings” are in four main sections, as follows:

### 1. V — EMI

Here you will learn about electromagnetic interference and how it can affect your chair.

### 2. VI — GENERAL WARNINGS

Here you will find a safety checklist and a summary of risks you need to be aware of before you ride this chair.

### 3. VII — WARNINGS — COMPONENTS & OPTIONS

Here you will learn about your chair. Consult your supplier and your health care professional to help you choose the best set-up and options for your safety.

### 4. XI — BATTERIES

Here you will learn about battery and charger safety, and how to avoid injury.



**Q-NOTE**— Where they apply, you will also find “Warnings” in other sections of this Manual.

Throughout this owner’s manual and on the wheelchair you will see the icons listed below to identify warnings and potential hazards. It is important to read and understand all of them and understand them.



**WARNING!** These warnings must be followed, failure to do so may cause personal injury or may damage the wheelchair.



**PROHIBITED!** Prohibited actions must never be performed. Performing an action that is prohibited can cause personal injury or may damage the wheelchair.



**Q-NOTE:** Q-Notes are informative statements to help further explain actions, warnings or product detail.



**ESD:** Electrostatic Discharge has a potential to damage printed circuit boards unless handled correctly. When the ESD symbol is shown throughout the owner manual, use the Proper Handling Techniques Insert supplied with the chair to properly handle printed circuit board.

## V. EMI (ELECTROMAGNETIC INTERFERENCE)

### WARNING

**Heed all warnings to reduce the risk of unintended brake release or chair movement:**

1. **Beware of the danger from hand-held transceivers. Never turn on or use a hand-held transceiver while power to your chair is on. Use extra care if you believe that such a device may be in use near your chair.**
2. **Be aware of nearby radio or TV stations, and avoid coming close to them.**
3. **If unintended movement occurs, turn your chair off as soon as it is safe to do so.**

## A. WHAT IS EMI?

### WARNING

1. EMI means: electromagnetic (EM) interference (I). EMI comes from radio wave sources such as radio transmitters and transceivers. (A “transceiver” is a device that both sends and receives radio wave signals).

2. There are a number of sources of intense EMI in your daily environment. Some of these are obvious and easy to avoid. Others are not, and you may not be able to avoid them.
3. Powered wheelchairs may be susceptible to electromagnetic interference (EMI) emitted from sources such as radio stations, TV stations, amateur radio (HAM) transmitters, two way radios, and cellular phones.
4. EMI can also be produced by conducted sources or electrostatic discharge (ESD).

## B. WHAT EFFECT CAN EMI HAVE?

### WARNING

1. EMI can cause your chair, without warning, to:
  - Release its brakes
  - Move by itself
  - Move in unintended directions
 If any of these occurs, it could result in severe injury to you or others.
2. EMI can damage the control system of your chair. This could create a safety hazard, and lead to costly repairs.

## C. SOURCES OF EMI

### WARNING

The sources of EMI fall into three broad types:

#### 1. Hand-Held Transceivers:

The antenna is usually mounted directly on the unit. These include:

- Citizens band (CB) radios
- “Walkie-talkies”
- Security, fire and police radios
- Cellular phones
- Lap-top computers with phone or fax
- Other personal communication devices

 **Q-NOTE**– These devices can transmit signals while they are on, even if not in use.

#### 2. Medium-Range Mobile Transceivers:

These include two-way radios used in police cars, fire trucks, ambulances and taxi cabs. The antenna is usually mounted on the outside of the vehicle.

#### 3. Long-Range Transceivers:

These include commercial radio and TV broadcast antenna towers and amateur (HAM) radios. **NOTE**– The following are not likely to cause EMI problems: Lap-top computers (without phone or fax), Cordless phones, TV sets or AM/FM radios, CD or tape players.

## D. DISTANCE FROM THE SOURCE

### WARNING

EM energy rapidly becomes more intense as you get closer to the source. For this reason, EMI from hand-held devices is of special concern. (See C.1 above) A person using one of these devices can bring high levels of EM energy very close to your chair without you knowing it.

## E. IMMUNITY LEVEL

### WARNING

1. The level of EM is measured in volts per meter (V/m). Every power wheelchair can resist EMI up to a certain level. This is called its “immunity level”.
2. The higher the immunity level, the less the risk of EMI. It is believed that a 20 V/m immunity level will protect the power wheelchair user from the more common sources of radio waves.
3. The configuration tested and found to be immune to at least 20 V/m is: Quickie Rhythm power wheelchair with a right-hand mounted Delphi remote joystick system, 18" seat width, 18" seat depth, dual post height adjustable armrests, fixed tapered legrests with one piece solid footplate, and Gp 24 gel cell batteries.

4. The following specialty input devices have an unknown effect on the immunity level because they have not been tested with the Rhythm and Delphi control system:

- |   |                        |
|---|------------------------|
| • Breath Control                          | • Star Board           |
| • Proportional Head Control               | • Proximity Head Array |
| • Tri-Switch Head Array                   | • Wafer Board          |
| • Proportional Mini-Joystick/Chin Control | • Zero Touch Switch    |
| • Heavy Duty Switched Joystick            | • Penta Switch         |
| • Buddy Button                            | • 4-Zero Touch Switch  |
| • Treadle Switch                          | • Plate Switch         |
| • Micro Light                             | • 5-Zero Touch Switch  |
| • Ribbon Switch                           | • Soft Switch          |
|   | • Disc Switch          |
|   | • Grasp Switch         |
|   | • Wobble Switch        |

### WARNING

Individuals with physical limitations requiring the use of a specialty control input device known not to be immune to 20V/m, or not known, should exercise extra care around known sources of EMI.

### WARNING

There is no way to know the effect on EMI if you add accessories or modify this chair. Any change to your chair may increase the risk of EMI. Parts not specifically tested or parts from other suppliers have unknown EMI properties.

## F. REPORT ALL SUSPECTED EMI INCIDENTS

### WARNING

You should promptly report any unintended movement or brake release. Be sure to indicate whether there was a radio wave source near your chair at the time. Contact:

Sunrise Medical, Customer Service Department at (800) 333-4000.

## G. EMI FROM CHAIR

### WARNING

The chair itself can disturb the performance of electromagnetic fields such as emitted by alarm systems of shops.

**⚠ WARNING**

Heed all warnings in this section. If you fail to do so a fall, tip-over or loss of control may occur and cause severe injury to you or others.

**A. NOTICE TO USER AND ATTENDANTS****⚠ WARNING****User**

1. Before using this chair, you should be trained in its safe use by your health care professional.
2. Every wheelchair is different. Take the time to learn the feel of this chair before you begin riding.
3. Be aware that you must develop your own methods for the safe use of this chair, that are best suited to your level of function and ability.
4. Have someone help you practice bending, reaching and transfers until you learn how to do them safely.
5. Never try a new maneuver on your own unless you are sure it is safe.
6. Get to know the areas where you plan to use your chair. Look for hazards and learn how to avoid them.
7. Always wear a positioning strap.
8. Do not use a wheelchair if the joystick does not spring back to the neutral position.
9. Do not use your wheelchair if the joystick boot is ripped or damaged.
10. Do not try to tip this wheelchair without an attendant present.

**User and Attendants**

1. When transferring the user in or out of the wheelchair never use the footplate as a platform.
2. Do not lift this wheelchair by any parts that are removable, doing so may result in damage to the wheelchair or injury to the user.
3. Never try to stop or slow this wheelchair with the wheel locks (if applicable). Wheel locks are designed to prevent the chair from moving when stopped. They are not brakes.
4. Always keep your hands and body parts clear of moving parts to help prevent injuries.

**Attendants****⚠ WARNING**

Make sure you heed all warnings and follow all instructions in each section of this manual. Be aware that warnings that apply to the user also apply to you.

1. Do not stand or sit on any portion of this wheelchair.
2. You need to work with the user, and the user's doctor, nurse or therapist, to develop safe methods best suited to your abilities and those of the user.
3. To manually push the chair you must release the motor locks.
  - Do not engage or disengage motor locks **unless** power to the chair is **off**. In addition, make sure both free wheel levers are completely pushed in before turning the power on to ensure the wheelchair can be driven in a straight forward motion.
  - Make sure you have full control over the chair when you release the motor locks. When you do so the chair will not have brakes.

- Make sure the chair is on level ground before you release the motor locks.

**NOTE**– To release the wheel locks the wheel chair may need to be rocked back and forth slightly several times before the lock will release.

4. Propel this chair by the push handles only. They provide secure points for you to hold the rear of the chair to prevent a fall or tip-over.
  - Check to make sure push handle grips will not rotate or slip off.

**B. WEIGHT LIMIT****⚠ WARNING**

1. The user plus items carried should never exceed the total weight capacity identified on your chair.
2. Never use this chair for weight training if the total weight (user plus additional weights) exceeds weight capacity.
3. Exceeding the weight limit is likely to damage the seat, frame, or fasteners, and may cause severe injury to you or others from chair failure.
4. Exceeding the weight limit will void the warranty.

**C. CONTROLLER SETTINGS****⚠ WARNING**

Be aware that you may need to adjust the controller settings of your chair.

1. Check and adjust the settings every six to twelve months.
2. Consult your supplier to adjust the control settings immediately if you notice any change in your ability to:
  - Control the joystick
  - Hold your torso erect
  - Avoid running into objects.

**D. EMI****⚠ WARNING**

Read Section V to learn about EMI. To reduce the risk of unintended brake release or chair movement:

1. Never turn on or use a hand-held transceiver while power to your chair is on. Use extra care if you believe that such a device may be in use near your chair.
2. Be aware of nearby radio or TV stations, and avoid coming close to them.
3. If unintended movement or brake release occurs, turn your chair off as soon as it is safe.

**E. SAFETY CHECK-LIST****⚠ WARNING**

Before each use of this chair:

1. Make sure the chair operates smoothly. Check for noise, vibration, or a change in ease of use. (They may indicate low tire pressure, loose fasteners, or damage to your chair).
  - If you detect a problem, make sure to repair or adjust the chair. Your supplier can help you find and correct the problem.
2. Make sure batteries are charged. Green lights on charge indicator will light up when charge is full. Yellow lights indicate battery charge level is getting low. Red lights indicate batteries are in immediate need of charging.

## F. CHANGES & ADJUSTMENTS

### PROHIBITED!

Never use non-Quickie parts to replace Quickie provided parts or make changes to your chair unless authorized by Sunrise. (Doing so will void the warranty and may create a safety hazard.)

### WARNING

**Accessories designed by manufacturers other than Sunrise, not available through Sunrise order process have not been tested or approved for use by Sunrise.**

1. If you modify or adjust this chair it may increase the risk of a fall or tip-over.
2. Modifications unauthorized by Sunrise constitutes remanufacturing of the wheelchair. This voids the warranty. The user then assumes all future liability for the wheelchair.

## G. WHEN SEATED IN A PARKED WHEELCHAIR

### WARNING

1. Always turn off all power to your chair when you are parked, even for a moment. This will prevent:
  - Accidental movement from contact with the joystick by you or others.
  - Unintended brake release or movement from EMI sources. (See Section V)
2. Make sure that persons who help you (for example, store clerks) are aware of the joystick and do not touch it. If they do, your chair may move suddenly when you do not expect it.

## H. ENVIRONMENTAL CONDITIONS

### WARNING

Your chair is not designed for use in a heavy rain storm, or in snowy or icy conditions.

1. Contact with water or excessive moisture can cause an electrical malfunction. The frame, motors and other chair parts are not water-tight and may rust or corrode from the inside. To avoid a chair failure:
  - Minimize exposure of your chair to rain or very wet conditions.
  - Never take your chair into a shower, tub, pool or sauna.
  - Do not use your chair in fresh or salt water (such as at the edge of a stream, lake, or ocean).
  - Make sure battery cover is secure.
  - Replace joystick boot if it becomes torn or cracked.
  - Make sure all electrical connections are secure.
  - Dry the chair as soon as you can if it gets wet, or if you use water to clean it.
2. Proceed slowly and use extra care if you must operate your chair on a wet or slick surface.
  - When in doubt, have someone help you.
  - Do so only if you are sure it is safe.
  - Stop if one or both main wheels lose traction. If this occurs, you may lose control of your chair or fall.
  - Never operate your chair on a slope or ramp if there is snow, ice, water or oil film present.

3. When not in use, keep your chair in a clean, dry place.

### WARNING

**Extra caution should be used when employing the disc switch or the proximity head array as control devices. These two devices are susceptible to malfunction when wet.**

## I. TERRAIN

### WARNING

1. This chair will perform at optimum on firm, even surfaces such as concrete, asphalt and indoor flooring.
2. Although equipped with suspension, the performance can be substantially reduced on uneven surfaces and rough terrain.
3. Do not operate the chair on sand, loose gravel or soil. Doing so may damage wheels, bearings, axles, motors or loosen fasteners.

## J. STREET USE

### WARNING

In most states, power chairs are not legal for use on public roads. Be alert to the danger of motor vehicles on roads or in parking lots.

1. Do not operate this wheelchair on any roadways that do not allow non-motor vehicle traffic.
2. When visibility is limited by either darkness or weather conditions, do not operate the chair on any roadways.
3. It may be hard for drivers to see you. Make eye contact with drivers before you proceed. When in doubt, yield until you are sure it is safe.

## K. MOTOR VEHICLE SAFETY

Identify whether your chair has been manufactured with the Transit Option installed.

**If your chair is not equipped with the Transit Option:**

### WARNING

**If your chair is not equipped with Transit Option, this wheelchair does not meet federal standards for motor vehicle seating.**

1. NEVER let anyone sit in this chair while in a moving vehicle.
2. ALWAYS secure the rider with proper motor vehicle restraints. In an accident or sudden stop the rider may be thrown from the chair. Wheelchair seat belts will not prevent this, and further injury may result from the belts or straps.
3. NEVER transport this chair in the front seat of a vehicle. It may shift and interfere with the driver.
4. ALWAYS secure this chair so that it cannot roll or shift.
5. Do not use any chair that has been involved in a motor vehicle accident.

**If your chair is equipped with the Transit Option:**

See section VII-S: "Transit Use" and section VIII-L: "Transit Option".



## L. CENTER OF BALANCE

### WARNING

The point where this chair will tip forward, back, or to the side depends on its center of balance and stability.

#### The Center Of Balance Is Affected By:

1. The seat height and seat angle.
2. A change in your body position, posture or weight distribution.
3. Using this chair on a ramp or slope.
4. The use of a back pack or other options, and the amount of added weight.
5. Drive wheel positioning.

#### To Reduce The Risk Of A Fall Or Tip-Over:

Whenever a condition exists that may change the center of balance, reduce speed, proceed cautiously, and when in doubt, always have someone help you.

## M. TRANSFERS

### WARNING

It is dangerous to transfer on your own. It requires good balance and agility. Be aware that there is a point during every transfer when the wheelchair seat is not below you. To prevent a fall:

1. Always turn off power before you transfer to or from your chair. If you fail to do so you may touch the joystick and cause your chair to move when you do not expect it.
2. Make sure motor locks are engaged. This keeps the chair from moving when you transfer.
3. Work with your health care professional to learn safe methods.
  - Learn how to position your body and how to support yourself during a transfer.
  - Have someone help you until you are sure you can do a safe transfer on your own.
4. Move your chair as close as you can to the seat you are transferring to. If possible, use a transfer board.
5. Rotate the front casters until they are as far forward as possible.
6. Be careful of the footrests. If you can, remove or swing them out of the way.
  - Never stand on footrests when you transfer. Doing so may damage them or cause your chair to tip.
  - Make sure your feet do not “hang up” or get caught in the space between the footrests.
7. Make sure armrests do not interfere.
8. Transfer as far back onto the seat surface as you can. This will reduce the risk that you will miss the seat or fall.

## N. REACHING OR LEANING

### WARNING

Reaching or leaning affects the center of balance of your chair. If done improperly, a fall or tip-over is likely. When in doubt, ask for help or use a device to extend your reach.

#### To Reduce the Risk of injury and/or Damage to the Chair:

1. Never reach or lean if you must shift your weight sideways or rise up off the seat.
2. Never reach or lean if you must move forward in your seat to do so. Always keep your buttocks in contact with the backrest.
3. Never reach with both hands (you may not be able to catch yourself to prevent a fall if you lose your balance).

4. Never try to pick up an object from the floor by reaching down between your knees.
5. Never put pressure on the footrests while reaching.
6. Never reach or lean over the top of the seat back. This may damage the backrest and cause you to fall.

## IF YOU MUST REACH OR LEAN DO SO AT YOUR OWN RISK.

#### Remember to:

1. Move your chair as close as you can to the object you wish to reach.
2. Rotate the front casters until they are as far forward as possible. This makes the chair more stable.

 **Q-NOTE**– To do this: Move your chair past the object you want to reach, then back up alongside it. Backing up will rotate the casters forward.

3. Turn off all power to your chair. If you fail to do so, you may touch the joystick and cause your chair to move when you do not expect it.

## O. DRESSING OR CHANGING CLOTHES

### WARNING

Be aware that your weight will shift if you dress or change clothes while seated in this chair. To make the chair more stable, rotate the front casters until they are **forward**.

## P. OBSTACLES

### WARNING

Obstacles you may have to overcome in daily use include door thresholds, lifts, ramps and hazards such as potholes and broken pavement. These can damage your chair and may cause a fall, tip-over or loss of control.

1. Be aware that thresholds are very dangerous. (Even a small change in height may stop a caster wheel and cause your chair to tip). You may need to:
  - Remove or cover threshold strips between rooms.
  - Install a ramp at entry or exit doors.
2. Keep your eyes moving when you ride; scan the area well ahead of your chair.
3. Make sure the floor areas where you use this chair are level and free of obstacles.

## Q. DRIVING IN REVERSE

### WARNING

Use extra care when you drive your chair in reverse. You may lose control or fall if one of the rear wheels hits an object.

1. Operate your chair slowly and at an even speed.
2. Stop often and check to make sure your path is clear of obstacles.

## R. RAMPS, SLOPES & SIDEHILLS

### WARNING

The center of balance of your chair changes when you are on a slope.

 **Q-NOTE**– “Slope” includes a ramp or sidehill. Your chair is less stable when it is at an angle. Never use this chair on a slope unless you are sure it is safe. When in doubt, have someone help you.

**Beware Of:**

1. Steep slopes. Do Not use this chair on a slope steeper than 10%. (A 10% slope means: One foot in elevation for every ten feet of slope length).
2. Wet or slippery surfaces (such as when ice, snow, water or oil film is present). A loss of traction may cause a fall or tip-over.
3. A change in grade on a slope (or a lip, bump or depression). These may cause a fall or tip-over.
4. A drop-off at the bottom of a slope. (A drop-off of as small as 3/4 inch (19 mm) can stop a front caster and cause the chair to tip forward).

**S. TO REDUCE THE RISK OF A FALL, TIP-OVER OR LOSS OF CONTROL:****⚠ WARNING**

1. Never use your chair on a slope unless you are sure you can do so without losing traction.
2. Always go as straight up and as straight down as you can.
  - Do not “cut the corner” on a slope or ramp.
  - Do not turn or change direction on a slope.
3. Always stay in the center of the ramp. Make sure ramp is wide enough that you are not at risk that a wheel may roll off the side.
4. Keep your chair moving at a slow, steady speed. Keep control over the chair at all times.
  - On a descent, do not let your chair accelerate beyond its normal speed.
  - If the chair picks up speed, center the joystick to slow down or stop.

 **Q-NOTE**– The solid state controller of your chair has a logic system that will help control your speed when driving on a slope or uphill.

- If you stop, re-start slowly.

**T. RAMPS AT HOME & WORK****⚠ WARNING**

**Before driving on a ramp, survey the condition of the ramp. On slippery ramps traction may be reduced causing your wheelchair to slide.**

**⚠ WARNING**

**Make sure ramps meet all Building Codes for your area.**

1. For your safety, have a licensed contractor build or remodel ramp to meet all standards.
2.  **Q-NOTE**– The proper design will vary, depending on such things as: the length and height of the ramp; the need for an intermediate platform; landing size; doors, and the direction of swing, and; whether the ramp includes a turn or angle.

**At A Minimum:**

1. Open sides of ramp must have side rails to prevent your chair from going over the edge.
2. Slope must not be steeper than one inch in height for every one foot of slope length (approximately 10°).
3. Ramp surface must be even, and have a non-skid surface.
4. You may need to add a section at the top or bottom to avoid a lip or drop-off.
5. Ramp must be sturdy. Add bracing if needed, so ramp does not “bow” when you ride on it.

**U. WHEELCHAIR LIFTS****⚠ WARNING**

Wheelchair lifts are used in vans, buses, and buildings to help you move from one level to another.

1. Always turn **off** all power to your chair when you are on a lift. If you fail to do so, you may touch the joystick by accident and cause your chair to drive off the platform. (Be aware that a “roll-stop” at the end of the platform may not prevent this).
2. Make sure there is not a lip or drop-off at the top or bottom of the platform. These may cause a fall or tip-over. When in doubt, have someone help you.
3. Always position the user securely in the chair to help prevent falls while on a lift.
4. Avoid moving forward if a wheel is “hung up” on the lip of the ramp. Backup, reposition the caster for a more direct approach. And slowly try again.

**V. CURBS & SINGLE STEPS****⚠ WARNING**

1. It is recommended to climb and/or descend a curb, single step, or other obstacle that a ramp or curb cutout is always used.
2. If you must climb or descend a curb, single step, or other obstacle that is greater than 2.5", it is recommended to have a person assist you in doing so.
3. In no case should you try to climb a curb, single step, or other obstacle greater than 4" high.
4. If you must climb or descend a curb or step alone do so at your own risk using extreme care and follow the following procedure:
  - Proceed slowly, at a steady speed
  - Go as straight up or down as you can over the obstacle. Never turn when trying to climb or descend and obstacle, doing so may result in a fall or tip-over.
5. Failure to follow the above procedures may cause:
  - A Fall or Tip Over
  - Damage to the frame, wheels, axles or other parts, or loose fasteners.

**W. STAIRS****⊘ PROHIBITED!**

**Never use this chair to go up or down stairs, even with an attendant. Doing so is likely to cause a fall or tip-over.**

**X. ESCALATORS****⊘ PROHIBITED!**

**Never take this chair on an escalator, even with an attendant. Doing so is likely to cause a fall or tip-over.**

**⚠ WARNING**

**Note:** If you use parts or make changes not authorized by Sunrise it may create a safety hazard and will void the Warranty.

**A. ARMRESTS****⚠ WARNING**

Armrests will not bear the weight of this chair.

**🚫 PROHIBITED!**

Never lift this chair by its armrests. They may come loose or break.

**B. BATTERIES****⚠ WARNING**

Always wear rubber gloves and safety glasses when you handle batteries.

**🚫 PROHIBITED!**

Never smoke or hold an open flame near batteries. They are a known explosion hazard.

**⚠ WARNING**

1. Only **deep cycle sealed case** construction batteries should be used in this device.
2. To prevent an acid spill, always keep batteries **upright** (wet cell batteries).
3. Read all of section **X. Batteries** before attempting to change, or charge batteries.

**C. CUSHIONS & SLING SEATS****⚠ WARNING**

1. Standard foam cushions and other body supports are not designed for the relief of pressure.
2. If you suffer from pressure sores, or if you are at risk that they will occur, you may need a special seat system or a device to control your posture.
  - Consult your doctor, nurse or therapist to find out if you need such a device for your well-being.

**D. FASTENERS****⚠ WARNING**

Many of the screws, bolts and nuts on this chair are special high-strength fasteners. Use of improper fasteners may cause your chair to fail.

1. Only use fasteners provided by Sunrise.
2. If fasteners become loose, tighten them immediately.
3. Over- or under-tightened fasteners may fail or cause damage to chair parts.
  - See Section VIII, "Set-Up, Adjustment & Use", for proper torque settings.

**E. FOOTRESTS****⚠ WARNING**

1. At the lowest point, footrests should be **at least 2 1/2 inches** (65 mm) off the ground. If set too LOW, they may "hang up" on obstacles you can expect to find in normal use. This may cause the chair to stop suddenly and tip forward.
2. To avoid a trip or fall when you transfer:
  - Make sure your feet do not "hang up" or get caught in the space between the footrests.
  - Avoid putting weight on the footrests, as the chair may tip forward.
  - Remove or swing the footrests out of the way, if possible.
3. The footrest should always be in the down position when operating the chair.

**🚫 PROHIBITED!**

Never lift this chair by the footrests. Footrests detach and will not bear the weight of this chair. Lift this chair only by non-detachable parts of the main frame.

**F. MOTOR LOCKS****⚠ WARNING**

1. Do not engage or disengage motor locks **unless** power to the chair is **off**. In addition, make sure both free wheel levers are completely pushed in before turning the power on to ensure the wheelchair can be driven in a straight forward motion.
2. Be aware that the chair **will not have brakes** when motor locks are in the free-wheel position.
3. Make sure that the person pushing the chair has full control when motor locks are disengaged.
4. Make sure that the chair is on level ground when motor locks are disengaged.

**NOTE—** To release the wheel locks the wheel chair may need to be rocked back and forth slightly several times before the lock will release.

**G. ON/OFF SWITCH****⚠ WARNING**

1. **Never** use the ON/OFF switch to stop the chair **except** in an emergency. This will result in an **abrupt** stop, and may cause you to fall.
2. To slow your chair to a stop, return the joystick to neutral.

**H. PNEUMATIC TIRES****⚠ WARNING**

Proper inflation extends the life of your tires and makes your chair easier to use.

1. Do not use this chair if any of the tires are under- or over-inflated. Check weekly for proper inflation level, as listed on the tire sidewall.
2. Low pressure in a tire may cause the chair to veer to one side and result in a loss of control.
3. An over-inflated tire may burst.
4. **Never** use a gas station air pump to inflate a tire. Such pumps provide air at **high volume**, and could cause the tire to burst. To prevent tire damage:
  - Use a hand pump (or **low volume** air pump) to inflate tires.
  - Use a tire gauge to check pressure.
5. Driving over sharp objects may cause damage to pneumatic tires and tubes.

## I. POSITIONING BELTS (OPTIONAL)

### WARNING

Use a positioning belt only to help support your posture. Improper use of such belts may cause severe injury or death.

1. Make sure you are not at risk to slide down in the wheelchair seat. If this occurs, you may suffer chest compression or suffocate due to pressure from the belt.
2. A pelvic wedge or a similar device can help keep you from sliding down in the seat. Consult your health care professional to find out if you need such a device.
3. The belt must be snug, but must not be so tight that it interferes with breathing. You should be able to slide your open hand, flat, between the belt and your stomach.
4. Make sure you can easily remove the belt in an emergency.

### PROHIBITED!

**Never use a positioning belt:**

- In place of a motor vehicle seat belt. In an accident or sudden stop you may be thrown from the chair. A positioning belt will not prevent this, and further injury may result from the belt.
- As a restraint. A restraint requires a doctor's order.
- On a user who is comatose or agitated.

## J. PUSH HANDLES

### WARNING

1. Push handles provide secure points for an attendant to propel and control the chair. This helps to prevent a fall or tip-over.
2. Check to make sure push handle grips will not rotate or slip off.

## K. SEATING SYSTEMS

### WARNING

1. Use of a seating system not approved by Sunrise may alter the center of balance of this chair. This may cause a fall or tip-over.
2. **Never** change the seating system of your chair unless you consult your supplier first.
3. Never raise your seating system to a height of more than 22" (measuring from the front of the seat pan to the floor).

## L. UPHOLSTERY FABRIC

### WARNING

1. Replace worn or torn fabric of seat sling and seat back as soon as you can. If you fail to do so, the seat may fail and cause you to fall. Worn fabrics may increase the potential for a fire hazard.
2. Sling fabric will deteriorate with age and use. Look for fraying, thin spots, or stretching of fabric at rivet holes. Replace fabric as required.
3. Be aware that washing may reduce flame retardation of the fabric.

## M. POWER SEATING

### WARNING

#### 1. Operation

- While driving this wheelchair in the reclined, elevated, or tilted position use caution.
- Do Not attempt to operate any power seating option while positioned on an incline.
- Do Not attempt to operate any power seating option while this wheelchair is in motion.
- Do not attempt to operate the lift or tilt power seating options around children.
- Through programming it is possible to reverse the direction of all powered seating functions, ensure you know which direction your seat is going to move before operating.

#### 2. Reduced Speed Driving (Creep)

This power chair is designed to automatically reduce the maximum driving speed to a creep mode when certain power seating limits are reached.

#### 3. Pinch points

Pinch points may occur when operating the powered seating options on this chair. Ensure all hands and body parts are clear of all power seating components that may result in pinch points before operating them.

#### 4. Tilting Power Base with Push Handles

Do not attempt to tilt power wheelchairs by pulling down on the push handles. Power wheelchairs have heavy bases. As such, attempting to tilt a power wheelchair to traverse obstacles can damage components in the seating system and/or modular actuators.

#### 5. Remain Clear During Power Accessory Operation

Please stay clear of any powered actuator while the component is in motion. Sunrise power mechanisms move over large ranges of travel. Users should be aware of their surroundings while components are in motion.

#### 6. Maximum User Weight

Do not exceed the weight capacity for your specific chair/seating system configuration. Doing so could result in premature failure or injury.

#### 7. Latch Mode

While operating any power seating function in latched mode use caution. In latch mode, powered seating will not stop until a reverse command is performed or the end of travel is met.

## N. ASSIGNABLE CONTROLS

### WARNING

It is possible to assign a function to an input control (buttons, jacks) of your wheelchair. If controls have been assigned to perform a dual or alternate function ensure you know what each control operates. A list of the assigned functions should have been supplied with the wheelchair if this feature is programmed. Please contact your dealer or the Quickie Technical Service Department if you do not receive this information. Failure to do so may result in damage and/or injury.

## O. CG TILT POWER ACCESSORY

### WARNING

The powered CG Tilt accessory for this chair has a maximum user weight capacity of up to 400 lbs. Never exceed this capacity while operating the powered actuator.

## P. POWER RECLINE

### WARNING

#### Pinch Point

Avoid putting hands or fingers near the power recline mechanism while in operation.

#### Weight Capacity

The maximum user weight capacity for the power recline is up to 300 lbs. Exceeding this weight capacity could lead to injury and/or permanent damage to the equipment.

## Q. POWER LEGREST ACCESSORY

The power legrest accessory for the Rhythm has a maximum user weight capacity of up to 300 lbs or 400 lbs depending on your chair configuration. Never exceed this capacity while operating the powered actuator.

## R. TRANSIT USE

Refer also to sections VI-K: “Motor Vehicle Safety” and VIII-L: “Transit Option” for additional transit option and motor vehicle warnings.

### WARNING

1. If possible and feasible, the rider should transfer to the original Equipment Manufacturer vehicle seat and use the vehicle restraint.
2. If the wheelchair is used for transport, it must be used in a forward-facing seating position.
3. The rider must not weigh more than 300 lbs.
4. Use only with Wheelchair Tie-down and Occupant Restraint Systems (WTORS) that have been installed in accordance with the manufacturer’s instructions and SAE J2249.
5. Attach WTORS to securement points in accordance with the manufacturer’s instructions and SAE J2249.
6. Attach occupant restraints in accordance with the manufacturer’s instructions and SAE J2249.
7. Ensure hip guides are mounted to lock in place.

## NOTES

### 1. Work Surface For Set-Up:

Use a flat surface, such as a table, to assemble, adjust and check your chair. This makes the steps easier and helps ensure a correct set-up.

### 2. Fasteners:

- Many of the screws and bolts on this chair are special high-strength fasteners and may have special coatings.
- Many nuts are of the Nylock type. They have a plastic insert to help prevent loosening.
- Only use screws, bolts and nuts provided by Sunrise.

## WARNING

1. Use of improper fasteners may cause the chair to fail.
  2. Over- or under-tightened fasteners may fail or cause damage to chair parts.
  3. If bolts or screws become loose, tighten them as soon as you can. Loose bolts or screws can cause damage to other chair parts causing them to fail.
- ### 3. Washers & Spacers:
- Note the position of washers and spacers before disassembly.
  - To avoid damage to the frame, replace all washers and spacers when you reassemble parts.
- ### 4. Torque Settings:
- A torque setting is the optimal tightening for a particular fastener. Use a torque wrench that measures inch-pounds to secure screws, nuts and bolts on this chair.

## TOOLS YOU WILL NEED

### 1. Basic Tool Kit:

To set-up, adjust and maintain your chair you may need the following tools:

- Combined Phillips and flat screw driver
- Standard metric wrenches from 8mm - 14mm
- Metric Allen wrenches from 2mm - 5mm
- Imperial wrenches from 1/4" to 9/16"
- Imperial Allen wrenches from 5/64" to 1/4"

You can obtain a multi-purpose tool kit from Sunrise, or buy the tools you need from a hardware store.

### 2. Torque Wrench:

If you plan to adjust and maintain this chair yourself, Quickie recommends that you use a torque wrench.

 **Q-NOTE**– The wrench must measure inch-pounds (N.m). You can buy a torque wrench and proper sockets from a hardware store.

## CHECK-OUT

Be sure this chair performs to your chosen operational settings. If it does not, turn the chair off immediately and have the dealer reprogram.

 **Q-NOTE**– Repeat this procedure until the chair performs to your specifications

## WARNING

**When properly set-up, this chair will operate smoothly. Check to see that all components work properly. If you detect a problem, be sure to correct it before use.**

## A. BATTERY REMOVAL

To remove the batteries for transporting or servicing:

### Remove Batteries

- a. Remove both safety pins (A) from latch assembly.
- b. Lift levers on both sides and tilt seat back to allow access to the battery compartment.
- c. Remove the shroud cover by lifting up on the handle (B) as pictured.
- d. Disconnect both battery harnesses as pictured.
- e. Lift the battery from the compartment via the battery carrying straps.

### **⚠ WARNING**

**Batteries may weigh up to 55 lbs. (25 kg). Care must be taken to avoid injury when lifting.**

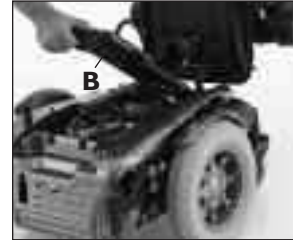
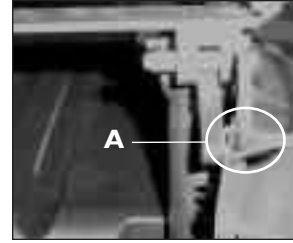

## B. FOLDING BACKREST

Quickie Rhythm wheelchairs are shipped with backrest in folded position. (optional)

### 1. Upright Positioning

- a. Lift backrest to upright position so that latch handles (C) lock into place.
- b. Backrest is ready for use.

### 2. Folding Backrest

- a. Lift and turn backrest latch handles (C) inward or outward.
- b. Fold backrest forward.

### **⚠ WARNING**

**Backrest latches must be locked into place before operating wheelchair.**

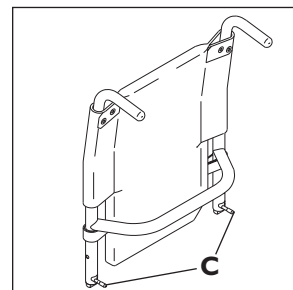

## C. SWING-AWAY FOOTRESTS

### 1. Installation

- Place swing-away pivot pin (B) into the locating hole (C) on top of the hanger mount with the footrest facing outward from frame.
- Rotate the footrest inward until latch plate locks (D) into place on locking bolt.

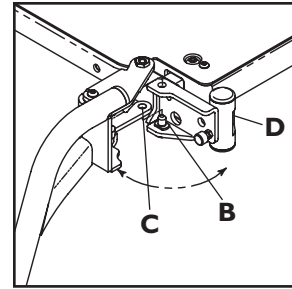

### 2. Removal

- To remove footrest, press quick-release lever (E).
- Rotate footrest outward and lift.

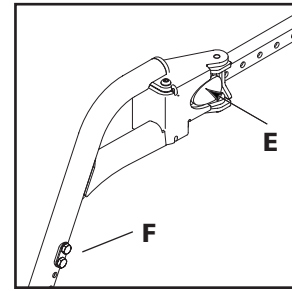

### 3. Height Adjustment

- Remove both bolts (F) in the hanger frame tube.
- Reposition footrest height.
- Re-tighten all bolts (F).

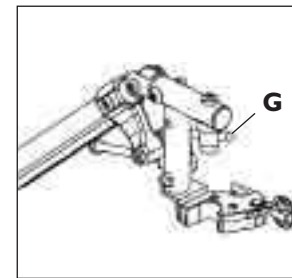

## D ELEVATING LEGREST (OPTIONAL)

### 1. Installation

To install or remove Elevating Legrest (ELR) see instructions for Swing-away Footrest installation.

### 2. Adjustment

- To raise legrest, lift to desired position. Legrest will automatically lock in place.
- To lower legrest, while seated in chair, first lift slightly then press release lever (G) down and lower legrest to desired position.

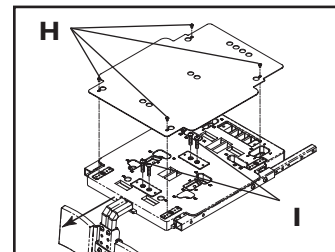

## E. CENTER MOUNT HANGER ADJUSTMENT

(ASAP Seating only)

### 1. Removal

- Remove the seat pan by removing the four attachment bolts (H).
- Remove the four bolts (I) and slide the footrest out.

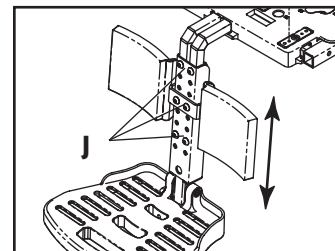

### 2. Height Adjustment

- Remove the six securing bolts (J).
- Move footplate to desired height.
- Re-install bolts (J) through desired holes.

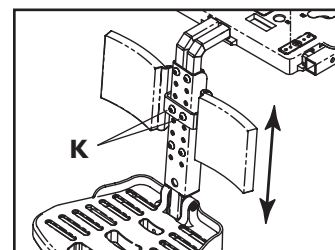

### 3. Calf Pad Adjustment

- Remove the two securing bolts (K).
- Move calf pads to desired height.
- Re-install bolts (K) through desired holes.



## F. JOYSTICK



### Controls:

- LED Joystick and color display joystick

### Omni Input/Display

The Omni is a universal specialty controls interface that accepts signals from many different types of SIDs and translates them into commands compatible with the PG Drives Technology RNET control system.

### Mating Connectors

To connect the communication cables:

Holding the connector housing, firmly push the connector into its mate until you can no longer see the yellow plastic. The connectors are secured using a friction system.

To disconnect the communication cables:

Holding the connector housing firmly, pull the connectors apart.

**NOTE-** Do not hold or pull on the cable. Always grip the connector when connecting and disconnecting.

When the control system is first switched on after a connection, or system component change, the timer will be displayed while the system checks itself. Then the re-start icon will be displayed. Switch the control system off and on again to operate,

## G. JOYSTICK RETRACTABLE MOUNT (Optional) (Fig. 10)

The joystick or Enhanced Display is mounted with a mechanism which allows the control to be locked in a forward or retracted position using magnets.

### Adjustment

- To retract the joystick, push outward on the inside of joystick.
- Push the joystick away from front of armrest until it locks into retracted position.
- To return to forward position, push the joystick forward until it locks into place.

## H. DUAL-POST HEIGHT-ADJUSTABLE ARMRESTS (OPTION), FIXED HEIGHT STANDARD

The dual-post flip-back armrest can be used as either a flip-back armrest or a removable armrest.

### 1. Installing Armrest

- Insert front and rear posts into armrest receivers.
- Engage levers (A and B) to secure armrest.

### 2. Set-up for Flip-back Operation

- Disengage lever (A) so front post is able to come free.
- Armrest now has the ability to be flipped back without removal.

### 3. Set-up for Removal

- Disengage levers (A and B) so front and rear posts are able to come free.
- Armrest can now be easily removed for transferring.

### 4. Height-Adjustment (option)

- Release the upper securing lever (C).
- Set at desired height
- Return securing lever to locked position.
- Move armrest up or down to allow armrest to snap into place

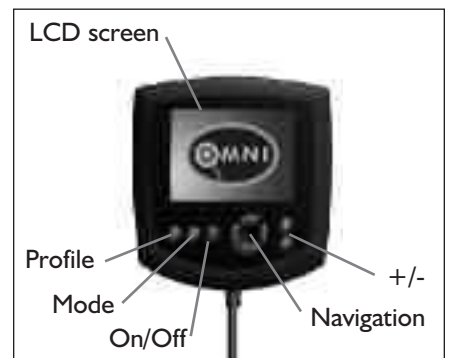
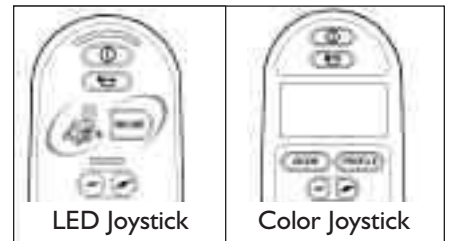
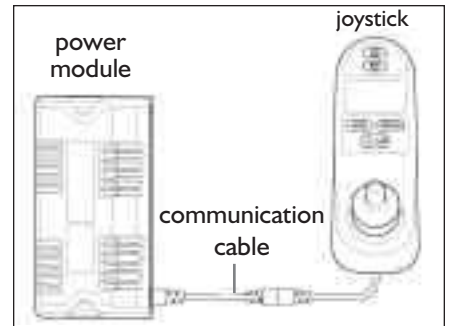

Omni Display

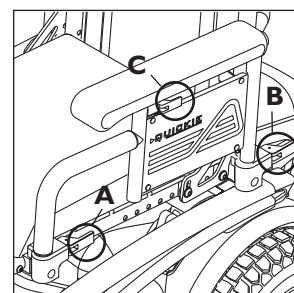
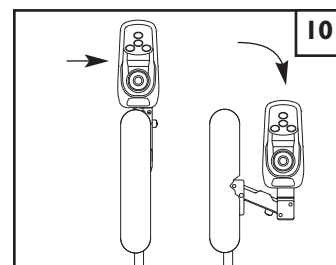
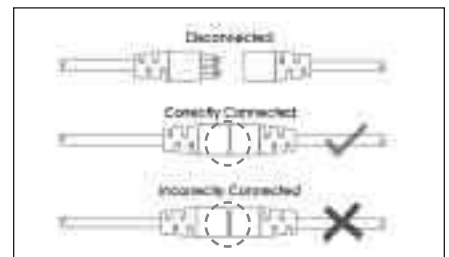

## I. SINGLE POST HEIGHT-ADJUSTABLE ARMRESTS (OPTIONAL)

### 1. Installation

- Slide the outer armrest into the receiver mounted to the wheel chair frame.
- The armrest will automatically lock into place.

### 2. Height Adjustment

- Rotate release lever to stop.
- Slide armrest pad up or down to desired height.
- Return lever to locked position.
- Push arm pad until upper armrest locks firmly into place.

### 3. Removing Armrest

- Rotate release lever and remove the armrest.

### 4. Replacing Armrest

- Slide armrest back into receiver.
- Return release lever to locked position against armrest.

### 5. Adjusting Armrest Receiver Fit

To tighten or loosen the fit of the outer armrest in the receiver:

- Loosen the four bolts on the sides of the receiver.
- With the armrest in the receiver, squeeze the receiver to achieve the desired fit.
- Tighten the four bolts.

### 6. Adjusting Inner Armrest Fit

- Two set screws are installed in the outer armrest.
- Turn the set screws in or out until the desired fit is achieved.

## J. SEAT DEPTH 14" - 16", 20" - 22" only

The seat depth can be adjusted in one inch increments on standard rehab seating.

### 1. Seat Frame Depth Adjustment

- To adjust, remove the two bolts (A & B) from each side of the backrest pivot plate.
- Reposition the backrest to the desired position.
- Replace and retighten bolts on each side of the backrest pivot plate.

### 2. Back Angle Adjustment on Seat Frame

- Remove the front securing bolt (A) on the side of the backrest hinge plate.
- Loosen the lower rear bolt (B)
- Set at desired angle. There are five holes (in 4° increments) to choose from.
- Reinstall the front bolt and tighten both bolts securely.

## K. TRANSIT OPTION

### **⚠** WARNING

- Use only Wheelchair Tie-down and Occupant Restraint Systems (WTORS) which meet the requirements of SAE J2249 Recommended Practice— Wheelchair Tie-down and Occupant Restraint Systems For Use in Motor Vehicles. Do not use WTORS designed to rely on the wheelchair structure to transfer occupant restraint loads to the vehicle.
- The wheelchair has been dynamically tested in a forward-facing mode for a 30 mph frontal impact test. The wheelchair must be forward-facing during transport.
- In order to reduce the potential of injury to vehicle occupants, wheelchair-mounted accessories, such as trays and respiratory equipment, should be removed and secured separately.
- Postural supports and positioning devices should not be relied on for occupant restraint.
- Do not alter or substitute wheelchair frame parts, components or seating.
- Sudden stops or impacts can structurally damage your chair. Chairs involved in such incidents should be replaced.

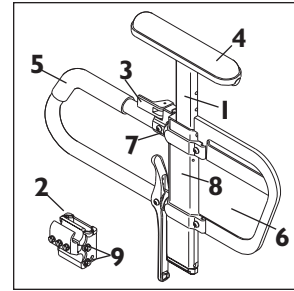

**Height-Adjustable Armrest Key**

- Inner Arm Post
- Receiver
- Release Lever, Locked Position
- Armrest Pad
- Transfer Bar
- Side Panel
- Tension Adjustment Set Screw
- Outer Arm Post
- Receiver Adjustment Bolts

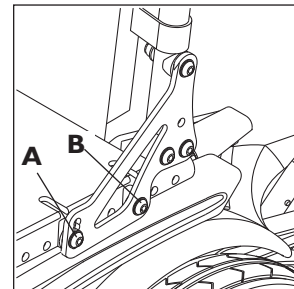

**SEATING SYSTEM SET-UP**

**A. ASAP SEATING ADJUSTMENT**

Please refer to the ASAP Seating Adjustment Guide for details on how to adjust the seat depth, seat width, armrest height and backrest angle.

**Pretilt**

- For 0° pretilt use holes 3 & 6 (Fig. 4) on bracket interface with hole B (Fig. 1) on curved bracket.
- For 5° pretilt use holes 3 & 6 (Fig. 4) on interface with holes B & C (Fig. 2) on curved bracket.
- For 9° pretilt use holes 3 & 6 (Fig. 4) on interface with holes A & C (Fig. 3) on curved bracket.

**B. SEAT PAN AND BACK SIZE ADJUSTMENTS**

Your Perfect Fit seating system can be adjusted to a wide range of widths and depths to accommodate specific user needs. Seating dimensions should only be altered by a trained professional and may require new seat cushions. Please refer to the Perfect Fit Growth Guide for more detailed instructions on how to customize the size of your seat.

**C. PRE-TILT (PACKER MODULE ONLY)**

The Packer Module can be mounted with the use of an additional mounting bracket to provide four different pre-tilt settings (0°, 3°, 6°, 9°). Figure 4 demonstrates these angles and how they can be achieved using the mounting bracket and two sets of screws. To achieve 0°, the Packer Module should be bolted directly to the seat frame interface.

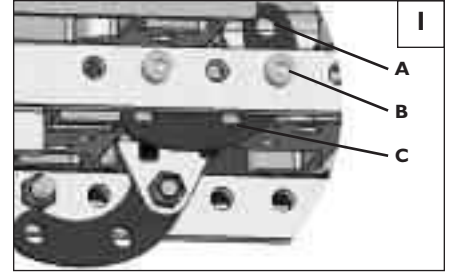

**SEATING SYSTEM ADJUSTMENT**

**A. MANUAL RECLINE OPERATION**

The Perfect Fit seating system has two manual recline options. The first is using a 16mm socket wrench and the second can be done by turning a knob on the side of the chair (Figure 5). To recline the chair, rotate this knob clockwise and turn the knob counter-clockwise to return the back to a more upright position.

**B. POWER RECLINE TILT/LIFT OPERATION**

The power recline, tilt, and lift features on your chair can all be operated using the joystick on your chair. Follow the instructions below to operate:

1. Make sure your controller is on.
2. From the Drive Mode, press the Mode button to enter Power Seating Mode.
3. Move the joystick left or right selecting the power option (recline, tilt, legrests) you wish to control.
4. Move the joystick forward or backward to adjust the selected power option to the desired position.
5. Press the Mode button to return to normal operation or continue moving the joystick left or right to adjust the next power option. Multiple Mode button presses will be necessary if other modules, such as Bluetooth or Output, are active.

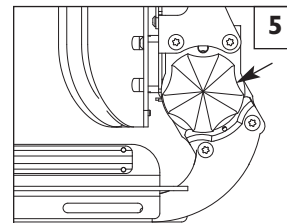
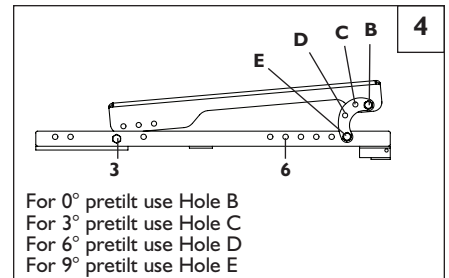

## A. PERFORMANCE CONTROL SETTINGS

 **Q-NOTE**– Seek advice regarding checking and adjusting settings.

1. It is vital to match control settings to your level of function and ability.
2. Consult your health care professional and your supplier to select the best control settings for you.
3. Check and adjust the settings every six to twelve months.

### **WARNING**

**Adjust the control settings immediately if you notice any change in your ability to:**

- Control the joystick.
- Avoid running into objects.

## B. ON BOARD PROGRAMMER OR DTT (DIAGNOSTIC TEST TOOL) OR RNET PC PROGRAMMER (Optional)

### **WARNING**

**Program settings beyond the ability of the user can result in serious injury. Consult your health care advisor before you alter settings.**

The On-board Programmer or RNET PC Programmer lets you adjust the control settings of the Pulse. Listed below are a few of the many settings that can be adjust via the On-board Programmer or RNET PC Programmer. (See RNET OBP Owners Manual for full programmable parameters.)

- acceleration rate
- deceleration rate
- turn acceleration
- turn deceleration
- forward speed (max & min)
- reverse speed (max & min)
- turn speed (max & min)
- steer correct

#### **Programming the Chair:**

- a. Access via OBP (On-board Programmer), DTT (Diagnostic Test Tool), or the PC Programmer. Each of these require inline connection to the communication cable.
- b. Program as needed.
- c. Remove Dongle or recycle power.

**NOTE**– Review the RNET OBP Owner's Manual for more details on how to program your chair.

## C. THERMAL ROLL-BACK

Your chair has a thermal roll back circuit. This protects the controller from damage due to overheating. In extreme conditions (such as repetitive hill climbing) the circuit will decrease the power to your motors. This allows the chair to operate at a reduced speed. When the controller cools, the chair will return to normal speed.

## D. FUSES

Your Quickie Rhythm has two inline fuses.

- In the unlikely event of a short circuit or other fault, all power to your chair will be shut off.
- Qualified service personnel are required to repair the fault and replace the battery harnesses.

## E. VR2 JOYSTICK ASSEMBLY

The standard VR2 joystick controls the chair's performance. It consists of the following parts:

### 1. Speed Control or Drive Mode Selection Buttons (A and B)

To decrease the speed level depress button A. Or, when 1- 5 Drive modes are programmed, depress button A to activate lower drive mode(s).

To increase speed level, depress button B. Or, when 1- 5 Drive modes are programmed, depress button B to activate higher drive mode(s).

Speed level active, or Drive Mode selected, is indicated on display (C) by a series of five lights. One light indicates slowest level/mode currently active, while five lights indicates highest level/mode currently active.

### 2. Battery Charge Indicator (D)

- Green lights indicate that batteries are fully charged.
- Yellow lights indicate that batteries need recharging.
- When the lights stay in the red band, the batteries must be recharged.

### 3. On/Off Button (E)

Turning the chair on or off is accomplished by depressing button E.

### 4. Horn (F)

### 5. Joystick (G)

The joystick controls the direction and speed of your chair. Turn the chair on and move the joystick in the direction you want to go.

- Moving the joystick from the neutral (center) position disengages the motor locks, allowing the chair to move.
- The chair will move faster the more you move the joystick away from neutral.

**NOTE-** If your speed becomes hard to manage, release the Joystick and the chair will come to a complete stop.

- When you release the joystick it will return to neutral; the chair will slow to a stop and the motor locks will reengage.
- We recommend that you switch the chair off if you stop for any length of time. This will conserve battery power.

**NOTE-** Once the chair stops, switching the chair off will not affect the motor locks.

### 6. Joystick Boot (H)

Make sure the boot is not torn or cracked (this could allow debris, water or moisture to enter). If the boot is torn or cracked, replace it as soon as you can.

### 7. Tilt Control (SC only) (I)

This button once depressed allows you to control the up and down movement of the tilt. Press button "I". Then pull the joystick back to tilt the seat upward or push the joystick forward to tilt the seat downward. Pressing button "I" again will allow drive operations to resume.

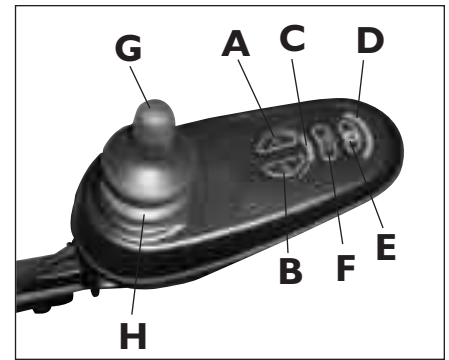

VR2 Joystick



VR2 Joystick with Actuator Control

## F. LED JOYSTICK

### On/Off Button

The on/off button applies power to the control system electronics, which in turn supply power to the wheelchair's motors. Do not use the on/off button to stop the wheelchair unless there is an emergency. (If you do, you may shorten the life off the wheelchair drive components.)

### Horn Button

The horn will sound while this button is depressed.

### Battery Gauge

The battery gauge show you that the wheelchair is switched on. It also indicates the operating status of the wheelchair.

- If the battery gauge shows red, yellow and green, the batteries are charged (bars 1 - 10).
- If the battery gauges show just red and yellow, then you should charge the batteries as soon as you can (bars 1 - 7).
- If the battery gauge shows just red, either steady or flashing slowly, then you should charge the batteries immediately (bars 1 - 3).

### Maximum Speed/Profile Indicator

This is a gauge that shows the maximum speed or profile setting of the wheelchair. There are five speed/profile settings— step 1 is the lowest speed and step 5 is the highest.

### Speed Decrease Button

This button decreases the maximum speed setting or, if the control system is programmed for drive profile operation, selects a lower drive profile.

### Speed Increase Button

This button increases the maximum speed setting or, if the control system is programmed for drive profile operation, selects a higher drive profile.

### Mode Button

The Mode button allows the user to navigate through the available operating modes for the control system. The available modes are dependent on programming and the range of auxiliary output devices connected to the control system.

### Actuator Indicator

This LED set displays which actuator channel is currently being controlled when the control system is in Actuator Mode. Actuator selection and operation is achieved using the joystick.

- Motions to the LEFT or RIGHT select different actuator channels.
- Motions FORWARD and BACKWARD move the actuator(s) selected.

### Speed Indication

The number of LED's illuminated shows the maximum speed setting. For example, if the setting is speed level 4, then the four left hand LED's will be illuminated.

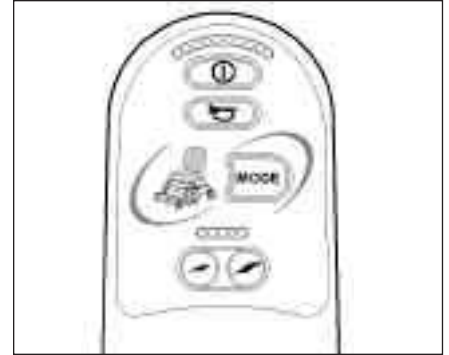

LED Joystick

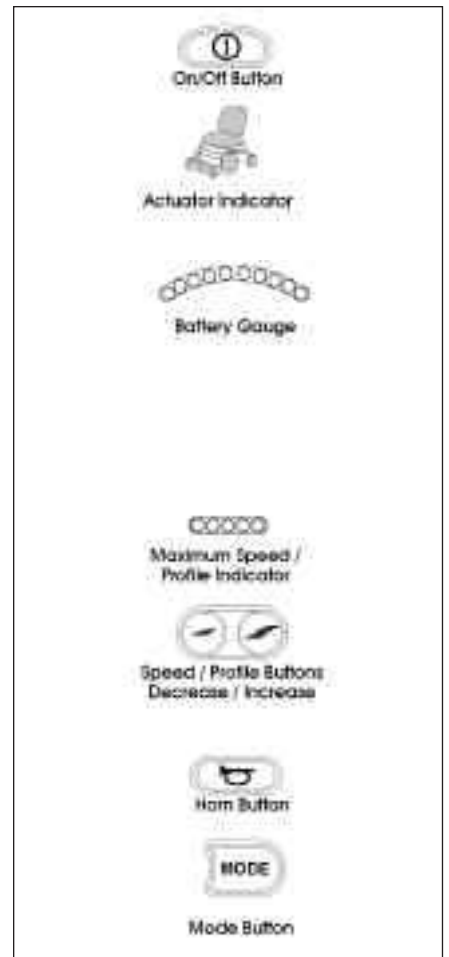

## G. COLOR LCD SCREEN

This section covers those joystick modules that are fitted with a color LCD screen. The color LCD screen is split into three areas of information. The Top Bar, the Base Bar and the Main Screen Area.

### Top Bar (Fig. 1 & 2)

**Battery Indicator (Fig. 2):** Displays the charge available in the battery and can be used to alert the user to the status of the battery.

**Steady:** Indicates that all is well.

**Flashing Slowly:** The control system is functioning correctly, but you should charge the battery as soon as possible.

**Stepping Up:** The wheelchair batteries are being charged. You will not be able to drive the wheelchair until the charger is disconnected and you have switched the control system off and on again.

### Base Bar (Fig. 3)

**Current Profile:** The currently selected profile is shown in numeric form.

### Main Screen Area

#### Drive Screen

**Profile Name (Fig. 4):** This is a text string that displays the name of the currently selected profile.

**Clock (Fig. 5):** This displays the current time in a numeric format.

**Speed Display (Fig. 6):** This gives a proportional display of the wheelchair's speed.

**Maximum Speed Indicator (Fig. 7):** This displays the current maximum speed setting.

**Digital Speed Display (Fig. 8):** This displays the actual speed of the wheelchair derived from the motors.

**Inhibit (Fig. 9):** If the speed of the wheelchair is being limited; for example, by a tilted seat, then this orange symbol will be displayed.

#### Mode Screens

**Actuator Mode (Fig. 10):** Displays the sections of the chair currently selected for movement, the name given to the selection and a direction arrow showing what sort of movement is available.

**Speed Adjust (Fig. 11):** When Speed Adjust Mode is entered, the following screen shown in Figure 11 will be displayed.

**Message Window (Fig. 12):** The RNET displays warning icons and informational messages, in a dedicated message window.

**Restart (Fig. 13):** When the control system requires a reboot; for example, after a module re-configuration, this symbol will be flashed.

**Timer (Fig. 14):** This symbol is displayed when the control system is changing between different states. An example would be entering into Programming Mode. The symbol is animated to show the sands falling.

#### Diagnostic Screen (Fig. 15)

When the control system safety circuits have operated and the control system has been prevented from moving the wheelchair, a diagnostics screen will be displayed. This indicates a system trip, i.e. the RNET has detected a problem somewhere in the wheelchair's electrical system.

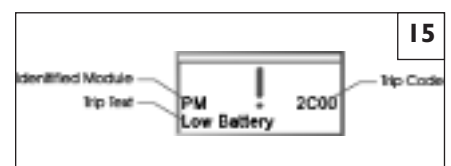
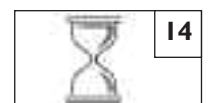
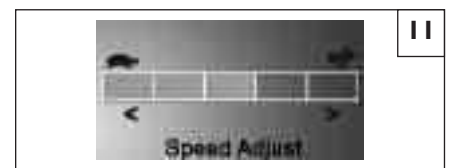
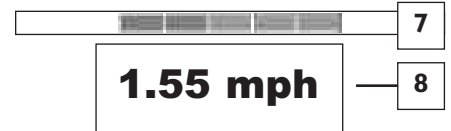
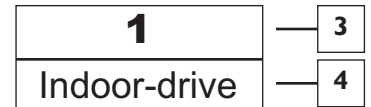
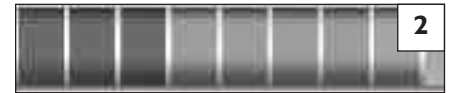
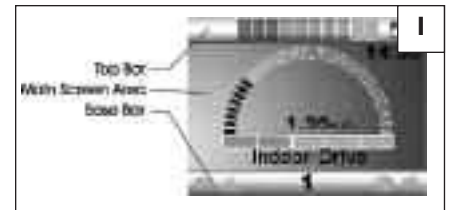

## H. MOTOR LOCKS

Disconnect the motor locks when you need to manually push the chair. (For example, in an emergency, or if batteries fail).

### **WARNING**

1. **Do not disengage motor locks unless power to the chair is off.**
2. **Be aware that the chair will not have brakes in the free-wheel position.**
3. **Make sure that the person pushing the chair has full control when motor locks are disengaged.**

#### 1. **To Disengage Motor Locks:**

Pull the lever out and away from the wheel to disengage the motor lock.

#### 2. **To Engage Motor Locks:**

Push the lever in to return to the drive position.



**Q-NOTE**— *If the lever is difficult to disengage, rock the wheelchair slightly from front to rear and/or push against the chair while moving the lever.*



## A. INTRODUCTION

### 1. Notes—

- Batteries supply the power for your chair. They contain a finite amount of energy and have limits on how long they can store and supply energy.
- You can charge batteries only a certain number of times before they will fail and no longer hold a charge.
- For answers to questions about batteries, consult your supplier.

### 2. Use Proper Batteries:

Your chair operates on two 12 volt batteries.

- They should be Group 24 (or 22NF) size with a minimum of 50 ampere hour rating. Only **deep cycle sealed case** construction batteries should be used in this device.
- Connecting configuration. They should have a post and clamp style connection.
- When you buy a replacement, insist on a **deep cycle sealed case** type. Do not use a car starter battery.
- Group 24 batteries are a minimum requirement for power seating.

### 3. Breaking In:

- A battery requires “breaking-in” for the first 6 to 12 charges. It will not accept a full charge for this period.
- It is best to limit the length of your trips until you break the batteries in and you know the range of your chair.

### 4. Discharged Batteries:

- **Never** allow a battery to completely discharge. If you operate your wheelchair until it has almost stopped, you will greatly reduce the life of your batteries.
- **Never** let a battery sit in a discharged condition. Give unused or stored batteries a full charge once per month.
- **Always** fully charge the batteries. **Avoid** “topping off” with frequent charges.

### WARNING

**Never connect a life support or auxiliary device to a wheelchair battery. The electrical system may fail, and result in severe injury to or death of user.**

## B. BATTERY CHARGER

A battery charger produces a direct current (DC). When applied to a discharged battery, this reverses the chemical reaction that led to its discharge.

### 1. Charge Rate. How fast a battery will charge depends on:

- Its electrical capacity; state of charge; electrolyte temperature, and; internal condition.
- The DC output of the charger. (The charge rate will vary if the alternating current (AC) supply is higher or lower than 110 volts).

### 2. Caution — To Avoid Damage to the Charger:

- Never place the charger on top of a battery during charging. (Gases from the battery can damage the charger and may lead to an explosion or fire).
- Never place a battery on top of the charger.
- Never expose charger to rain or snow.
- Never unplug charger by pulling on the electrical cord. This will damage the cord.
- Never open a charger or attempt to repair it yourself. Return charger to Sunrise or have repairs made only by a qualified person.

- Keep cord out of the way, where it will not be stepped on, tripped over, or damaged.

### 3. Caution — To Avoid Damage to the Battery:

- Make sure you use the correct setting for sealed (gel) batteries (located on the off-board charger).
- Never charge a frozen battery. A fully charged battery will rarely freeze, but the fluid in a discharged battery can freeze at 16 degrees Fahrenheit (minus 9 degrees Centigrade). If you suspect a battery is frozen, thaw it before charging.

### WARNING

**Lead acid batteries generate explosive gas while charging. Completely read and follow all warnings about the batteries in this user instruction manual and any labels applied to the product. Failure to do so could result in fire, explosion, injury and/or death.**

## C. ACID BURNS (unsealed wet cell batteries)

Acid in batteries is corrosive. It can cause serious burns to the eyes and skin and can damage floors, furniture, clothing and your wheelchair.

### WARNING

1. Use extreme care not to spill acid when you handle batteries. Keep batteries upright.
2. Avoid contact of acid with bare skin or clothing.
3. Always wear rubber gloves and safety glasses when you handle batteries.
4. If acid contacts your skin or clothing, wash immediately with soap and water.
5. If acid contacts your eyes, immediately flood eyes with cold running water for at least 15 minutes. Seek medical attention immediately.

## D. CONNECTING BATTERIES IN BATTERY COMPARTMENT

### WARNING

1. Batteries weigh up to 55 lbs. (25 kg). Take care to avoid injury when lifting.
2. Keep batteries upright. Take care not to spill acid (wet cell batteries).
3. Always wear rubber gloves and safety glasses when you handle batteries.
4. Before working around batteries, remove all metal personal effects, such as necklaces, rings, watches, pins and other metal jewelry that might contact battery terminal and cause a short.
  1. Lift batteries into battery compartment.

### WARNING

**Batteries weigh up to 55 pounds (25 kg). Lifting batteries may cause back strain. If you fail to heed these warnings severe injury may occur to you.**

2. Connect and disconnect battery cables with caution. Connect the red lead to the positive terminal and the black lead to the negative terminal. Do this for each battery.
3. Tighten all terminal fasteners using two 1/2" box end wrenches to 60 in-lbs (6.8 N.m).
4. Place the battery compartment lid on power base.

**⊘ PROHIBITED!**

Never make direct contact across both battery terminals, as an explosion may occur. A spark may result in an explosion and/or fire resulting in severe injury or death.

**E. CHARGING BATTERIES****⚠ WARNING**

To avoid the risk of severe injury or death from electrical shock, fire or explosion while charging:

**⊘ PROHIBITED!**

Never connect charger to a 240 volt source. The main input voltage is 110 volts.

**⚠ WARNING**

Never touch the charger after it is connected to an electrical outlet. This may cause electrical shock.

- Never connect or disconnect charger from battery while there is power to the charger.

**⚠ WARNING**

1. Never use an extension cord. Use of an improper cord could damage the charger or cause a fire or electrical shock.
2. A battery emits explosive hydrogen gas during charging. To reduce the risk of fire or explosion:
  - Make sure area is well vented. Never charge battery in a closed-in area.
  - Never smoke or allow a spark, flame or high heat near battery during charging.
  - Never allow metal tools or chair parts to make direct contact across both battery terminals.

3. Never look directly into cells when charging battery (wet cell batteries).

**ALWAYS:**

1. Use the charger that comes with your wheelchair. Read and follow all instructions and warnings.
2. Make sure room is well ventilated.
3. Turn off all power to your chair.
4. Connect and disconnect battery cables with caution.

 **Q-NOTE**– Always remove and reattach the negative cable (black cable) first.

5. Make sure to allow enough time to fully charge batteries.

 **Q-NOTE**– Batteries should never be left for long periods in the discharged state. Unused or stored batteries should be given a charge once per month.

6. To charge batteries, use the off-board charger by plugging off-board charger plug into the off-board charger socket.

**F. DISPOSING OF BATTERIES****⚠ WARNING**

1. All batteries once they have reached the end of their useful life are deemed to be hazardous waste.
2. For further information on handling and recycling contact your local recycling authority.
3. Always dispose of product through a recognized agent.

**XI. MAINTENANCE****A. NOTES**

1. Proper maintenance will improve performance and extend the useful life of your chair.
2. Clean your chair regularly. This will help you find loose or worn parts and will make your chair easier to use.
3. To protect your investment, have all major service and repair work done by your supplier.

**⚠ WARNING**

1. Your chair needs regular maintenance for peak performance and to avoid injury from chair failure, damage or premature wear.
2. Inspect and maintain this chair strictly per the “Maintenance Chart”.
3. If you detect a problem, make sure to service or repair the chair before use.
4. At least once a year, have a complete safety check and service of your chair performed by a supplier.

**B. CLEANING****1. Paint Finish:**

- Clean the paint finish with mild soapy water monthly.
- Protect the paint with a coat of non-abrasive auto wax every three months.

**2. Motors:**

- Clean around motor area weekly with a slightly damp (not wet) cloth.
- Wipe off or blow away any fluff, dust, or dirt on or around the motors.

 **Q-NOTE**– You do not need to grease or oil the chair.

**3. Upholstery:**

- Hand-wash only as needed. Machine washing may damage fabric.
- Drip-dry only. Heat from a dryer may damage fabric.

 **Q-NOTE**– Washing the fabric may decrease fire retardant properties.

**C. STORAGE TIPS**

1. Store your chair in a clean, dry area. If you fail to do so, parts may rust or corrode.
2. Before using your chair, make sure it is in proper working order. Inspect and service all items on the “Maintenance Chart”.
3. If you store this chair for more than three months, have it inspected by a supplier before use.

## D. BATTERY MAINTENANCE

### **⚠ WARNING**

1. To prevent an acid spill, always keep batteries upright (wet cell batteries).
2. Never smoke or hold an open flame near batteries.
3. Always wear rubber gloves and safety glasses when you handle batteries.

#### 1. Maintenance Schedule:

This varies for different types of batteries. Always follow the instructions supplied with your batteries.

**Q-NOTE**— Always wear rubber gloves and safety glasses when you handle or service batteries.

#### 2. Adding Water: (Wet Cells Only)

- Wet-type lead acid batteries need periodic replacement of water due to evaporation.

**Q-NOTE**— Use distilled water only.

- Check the battery fluid level about once a week. When you remove the stoppers (on top of the battery) there should be one-eighth to one-quarter of an inch of fluid above the internal plates. Do not overfill.

#### 3. Corrosion:

Check battery terminals often for corrosion.

- a. If corrosion is present, use a wire brush to clean the terminals.

**Q-NOTE**— Always wear safety glasses and rubber gloves.

- b. Use baking soda to neutralize acid.
- c. Use petroleum jelly to re-grease the terminals after connecting cable to battery. (Completely cover the terminal nut and bolt, cable clip and any exposed cable with jelly).

#### 4. For Answers To Questions: Contact your supplier.

## E. PNEUMATIC TIRES

### **⚠ WARNING**

1. Do not use this chair if any of the tires are under- or over-inflated.
2. Low pressure in a tire may cause the chair to veer to one side and result in loss of control.
3. An over-inflated tire may burst.
4. Never use a gas station pump to inflate a tire. Such pumps provide air at high volume, and may cause tire to burst.

1. Check for signs of wear and correct air pressure in pneumatic tires weekly.
2. For best performance, inflate tires to the same pressure level, as shown on the tire sidewall:
  - 14" pneumatic drive wheels— 35 to 45 psi (240 to 310 kpa)
3. **CAUTION**— To prevent tire damage:
  - Use a hand pump (or a low volume air pump) to inflate tires.
  - Use a tire gauge to check pressure.

## F. TO REPAIR OR REPLACE A TIRE

### **⚠ WARNING**

Residual air pressure in tires can cause severe injury. Make sure you release all air in tire before attempting to service or repair tires.

#### 1. 6" Caster Wheels:

- a. Remove caster wheel from fork using a 1/2" wrench.
- b. Make sure there is no residual air in tire before you remove bolts that hold the two rim halves together.
- c. Remove four bolts from rim using a #3 phillips screwdriver. Separate two halves of rim.
- d. Repair or replace inner tube.
- e. Reassemble the caster wheel; make sure the bearing spacer is in place and all four bolts are tightened to a torque of 60 in.-lbs. (6.8 N.m).
- f. Mount caster wheel onto fork. Install washers correctly tighten bolt to 240 in.-lbs. (27 N.m).

#### 2. 14" Drive Wheels:

- a. Elevate and securely support chair so that wheel is off the ground. Release all air from tire.
- b. Remove four (4) lug nuts (A) from rim using a socket wrench.
- c. Make sure all air has been removed from tire. Remove the eight bolts inside the rim. Separate two halves of rim (B).
- d. Repair or replace inner tube. Reassemble the wheel. Use a torque setting of 120 in.-lbs. (13.5 N.m) to re-tighten bolts.
- e. Inflate tire to proper pressure level (listed on tire sidewall).

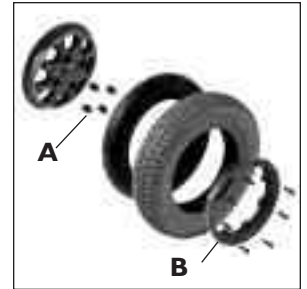

## G. ORDERING PARTS

When you order parts, provide the following:

1. Model of chair
2. Serial number of chair
3. Left hand or right hand control
4. Part number, description and quantity of parts you need.
5. State reason for replacement.

## H. MAINTENANCE CHART

You should check the items on this chart at the indicated intervals. If any of the items are loose, worn, bent or distorted, immediately have them checked and/or repaired by your authorized Sunrise supplier. Frequent maintenance and servicing will improve performance, extend wheelchair life, and help prevent injuries.

CHECK...	Daily	Weekly	Monthly	Quarterly	Annually
Charge Batteries		✓			
Check tires for proper inflation level			✓		
Check batteries for proper electrolyte level (wet only)			✓		
Check plugs and connectors for proper connections				✓	
Check all moving parts for wear					✓
Inspect all nuts, bolts and fasteners for looseness or wear					✓
Inspect upholstery for wear					✓
Service by authorized supplier					✓

XII. WIRING DIAGRAMS

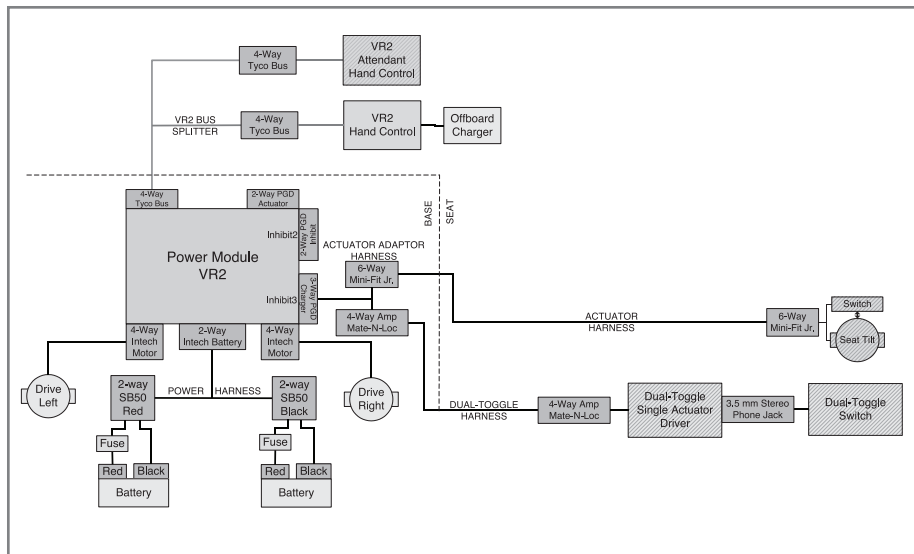

**VR2**  
Dual-Toggle Single Actuator

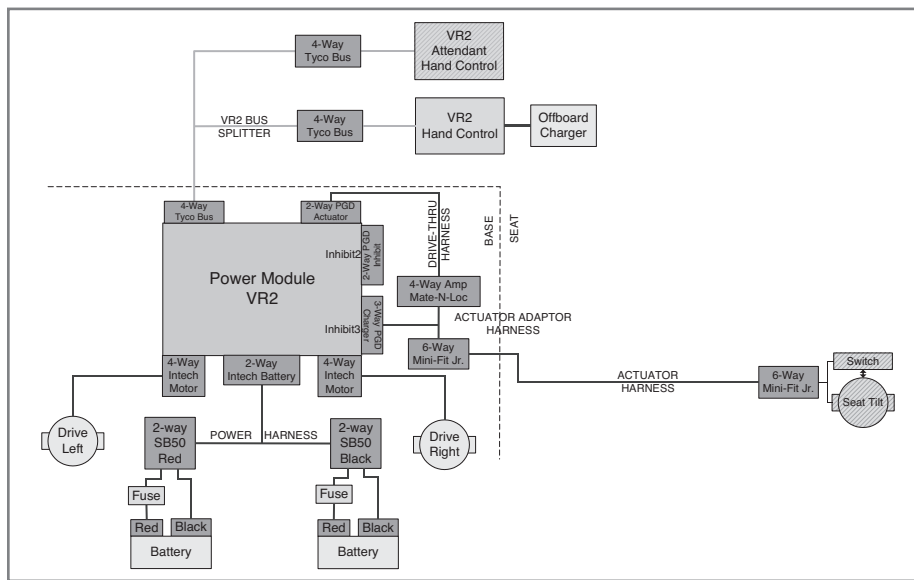

**VR2**  
Drive-Thru Single Actuator  
(with battery detail)

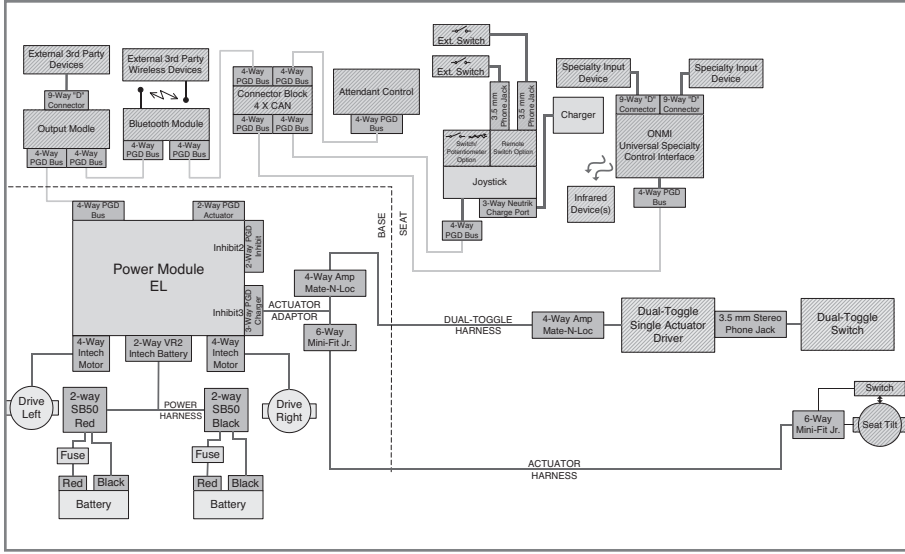

**RNET  
Dual-Toggle Tilt**

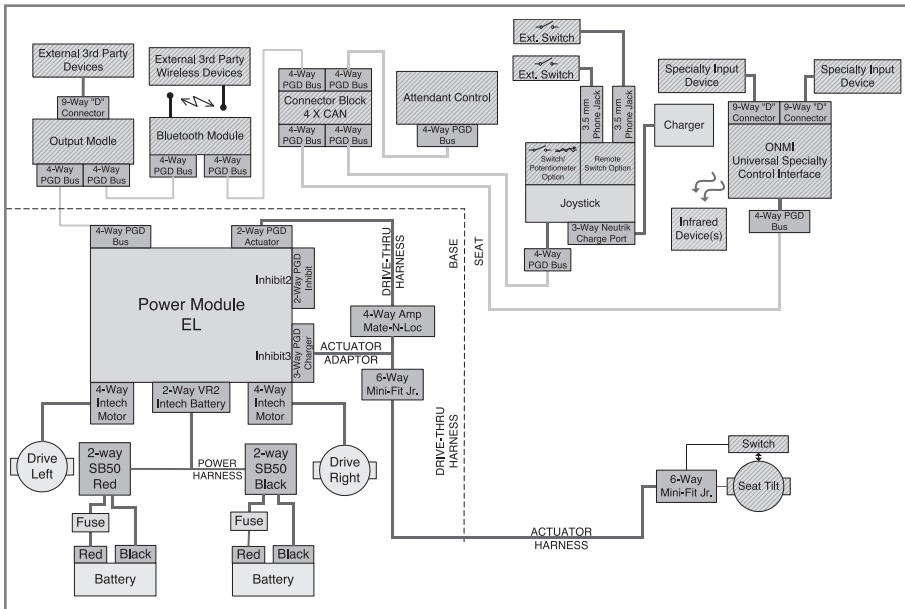

**RNET  
Drive-Thru Tilt**

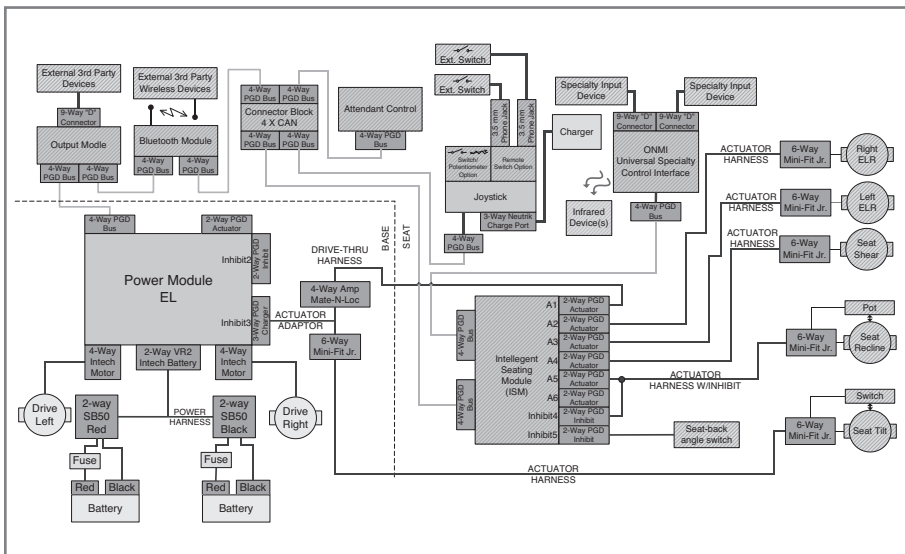

**RNET  
Multi-Actuator Option**

**A. FOR FIVE (5) YEARS**

Sunrise warrants the frame of this wheelchair against defects in materials and workmanship for five years from date of first consumer purchase.

**B. FOR ONE (1) YEAR**

We warrant all Sunrise-made parts and components of this wheelchair against defects in materials and workmanship for one year from the date of first consumer purchase.

**C. FOR ONE (1) YEAR**

We warrant all motors, gearboxes, batteries, and electronic components of this wheelchair against defects for one year from the date of first consumer purchase.

**D. LIMITATIONS**

1. We do not warrant:
  - a. Tires and tubes, upholstery, pads and push-handle grips.
  - b. Damage from neglect, accident, misuse, or from improper installation or repair.
  - c. Products modified without Sunrise Medicals express written consent.
  - d. Damage from exceeding the weight limit.
2. This warranty is VOID if the original chair serial number tag is removed or altered.
3. This warranty applies in the USA only. Check with your supplier to find out if international warranties apply.
4. This warranty is not transferable and only applies to the first consumer purchase of this wheelchair through an authorized Sunrise Medical dealer.

**E. WHAT WE WILL DO**

Our sole liability is to repair or replace covered parts. This is the exclusive remedy for consequential damages.

**F. WHAT YOU MUST DO**

1. Obtain from us, while this warranty is in effect, prior approval for return or repair of covered parts.
2. Return the wheelchair or part(s), freight pre-paid, to Sunrise Mobility Products Division at: 2842 Business Park Avenue, Fresno, CA 93727-1328.
3. Pay the cost of labor to repair, remove or install parts.

**G. NOTICE TO CONSUMER**

1. If allowed by law, this warranty is in place of any other warranty (written or oral, express or implied, including a warranty of merchantability, or fitness for a particular purpose).
2. This warranty gives you certain legal rights. You may also have other rights that vary from state to state.

Record your serial number here for future reference:

---

**Sunrise Medical Inc.**  
7477 East Dry Creek Parkway  
Longmont, Colorado 80503  
USA  
(800) 333-4000  
In Canada (800) 263-3390  
[www.sunrisemedical.com](http://www.sunrisemedical.com)



©2009 Sunrise Medical Inc. 4.09  
I12670 Rev. A